

HDPE тройник намалител на челна заварка SDR 26 PN 6

d1	s1	d2	s2	le 1	le2	z1	
63	11.7	50	5.4	70	80	175	
75	11.7	50	6.9	70	80	180	
75	11.7	63	8.6	70	80	190	
90	3.50	75	2.90	80	80	205	
90	3.50	63	2.50	80	80	180	
90	3.50	50	2.00	80	80	180	
110	4.20	90	3.50	90	80	215	
110	4.20	75	2.90	90	80	215	
110	4.20	63	2.50	90	80	190	
110	4.20	50	2.00	90	80	190	
125	4.80	110	4.20	90	80	215	
125	4.80	90	3.50	90	80	215	
125	4.80	75	2.90	90	80	215	
125	4.80	63	2.50	90	80	190	
125	4.80	50	2.00	90	80	190	
140	5.40	125	4.80	90	80	240	
140	5.40	110	4.20	90	80	215	
140	5.40	90	3.50	90	80	215	
140	5.40	75	2.90	90	80	215	
140	5.40	63	2.50	90	80	190	
160	6.20	140	5.40	100	80	250	
160	6.20	125	4.80	100	80	250	
160	6.20	110	4.20	100	80	225	
160	6.20	90	3.50	100	80	225	
160	6.20	75	2.90	100	80	225	
160	6.20	63	2.50	100	80	200	
180	6.90	160	6.20	100	100	275	
180	6.90	140	5.40	100	90	250	
180	6.90	125	4.80	100	90	250	
180	6.90	110	4.20	100	90	225	
180	6.90	90	3.50	100	80	225	

d1	s1	d2	s2	le 1	le2	z1	
180	6.90	75	2.90	100	80	225	
180	6.90	63	2.50	100	80	200	
200	7.70	180	6.90	100	100	300	
200	7.70	160	6.20	100	100	275	
200	7.70	140	5.40	100	90	250	
200	7.70	125	4.80	100	90	250	
200	7.70	110	4.20	100	90	225	
200	7.70	90	3.50	100	80	225	
200	7.70	75	2.90	100	80	225	
200	7.70	63	2.50	100	80	200	
225	8.60	200	7.70	100	100	325	
225	8.60	180	6.90	100	100	300	
225	8.60	160	6.20	100	100	275	
225	8.60	140	5.40	100	90	250	
225	8.60	125	4.80	100	90	250	
225	8.60	110	4.20	100	90	225	
225	8.60	90	3.50	100	80	225	
225	8.60	75	2.90	100	80	225	
225	8.60	63	2.50	100	80	200	
250	9.60	225	8.60	150	100	400	
250	9.60	200	7.70	150	100	375	
250	9.60	180	6.90	150	100	350	
250	9.60	160	6.20	150	100	325	
250	9.60	140	5.40	150	90	300	
250	9.60	125	4.80	150	90	300	
250	9.60	110	4.20	150	90	275	
250	9.60	90	3.50	150	80	275	
250	9.60	75	2.90	150	80	275	
250	9.60	63	2.50	150	80	250	
280	10.70	250	9.60	150	150	425	
280	10.70	225	8.60	150	100	400	
280	10.70	200	7.70	150	100	375	
280	10.70	180	6.90	150	100	350	
280	10.70	160	6.20	150	100	325	
280	10.70	140	5.40	150	90	300	
280	10.70	125	4.80	150	90	300	
280	10.70	110	4.20	150	90	275	
280	10.70	90	3.50	150	80	275	

d1	s1	d2	s2	le 1	le2	z1	
280	10.70	75	2.90	150	80	275	
280	10.70	63	3.80	150	80	250	
315	12.10	280	16.60	150	150	425	
315	12.10	250	14.80	150	150	425	
315	12.10	225	13.40	150	100	400	
315	12.10	200	11.90	150	100	375	
315	12.10	180	10.70	150	100	350	
315	12.10	160	9.50	150	100	325	
315	12.10	140	8.30	150	90	300	
315	12.10	125	7.40	150	90	300	
315	12.10	110	6.60	150	90	275	
315	12.10	90	5.40	150	80	275	
315	21.10	75	4.50	150	80	275	
315	21.10	63	3.80	150	80	250	
355	13.60	315	18.70	180	150	480	
355	13.60	280	16.60	180	150	455	
355	13.60	250	14.80	180	150	455	
355	13.60	225	13.40	180	100	430	
355	13.60	200	11.90	180	100	405	
355	13.60	180	10.70	180	100	380	
355	13.60	160	9.50	180	100	355	
355	13.60	140	8.30	180	90	330	
355	13.60	125	7.40	180	90	330	
355	13.60	110	6.60	180	90	305	
355	13.60	90	5.40	180	80	305	
400	15.30	355	21.10	180	180	530	
400	15.30	315	18.70	180	150	480	
400	15.30	280	16.60	180	150	455	
400	15.30	250	14.80	180	150	455	
400	15.30	225	13.40	180	100	430	
400	15.30	200	11.90	180	100	405	
400	15.30	180	10.70	180	100	380	
400	15.30	160	9.50	180	100	355	
400	15.30	140	8.30	180	90	330	
400	15.30	125	7.40	180	90	330	
400	15.30	110	6.60	180	90	305	
400	15.30	90	5.40	180	80	305	
450	17.20	400	23.70	200	180	575	

d1	s1	d2	s2	le 1	le2	z1	
450	17.20	355	21.10	200	180	550	
450	17.20	315	18.70	200	150	500	
450	17.20	280	16.60	200	150	475	
450	17.20	250	14.80	200	150	475	
450	17.20	225	13.40	200	100	450	
450	17.20	200	7.70	200	100	425	
450	17.20	180	6.90	200	100	400	
450	17.20	160	6.20	200	100	375	
450	17.20	140	5.40	200	90	350	
450	17.20	125	4.80	200	90	350	
450	17.20	110	4.20	200	90	325	
450	17.20	90	3.50	200	80	325	
500	19.10	450	17.20	200	200	625	
500	19.10	400	15.30	200	180	570	
500	19.10	355	13.60	200	180	550	
500	19.10	315	12.10	200	150	500	
500	19.10	280	10.70	200	150	475	
500	19.10	250	9.60	200	150	475	
500	19.10	225	8.60	200	100	450	
500	19.10	200	7.70	200	100	425	
500	19.10	180	6.90	200	100	400	
500	19.10	160	6.20	200	100	375	
500	19.10	140	5.40	200	90	350	
500	19.10	125	4.80	200	90	350	
500	19.10	110	4.20	200	90	325	
500	19.10	90	3.50	200	80	325	
560	21.40	500	19.10	250	200	725	
560	21.40	450	17.20	250	200	675	
560	21.40	400	15.30	250	180	625	
560	21.40	355	13.60	250	180	600	
560	21.40	315	12.10	250	150	550	
560	21.40	280	10.70	250	150	525	
560	21.40	250	9.60	250	150	525	
560	21.40	225	8.60	250	100	500	
560	21.40	200	7.70	250	100	475	
560	21.40	180	6.90	250	100	450	
560	21.40	160	6.20	250	100	425	
560	21.40	140	5.40	250	90	400	

d1	s1	d2	s2	le 1	le2	z1	
560	21.40	125	4.80	250	90	400	
560	21.40	110	4.20	250	90	375	
560	21.40	90	3.50	250	80	375	
630	24.10	560	21.40	250	250	775	
630	24.10	500	19.10	250	200	725	
630	24.10	450	17.20	250	200	675	
630	24.10	400	15.30	250	180	625	
630	24.10	355	13.60	250	180	600	
630	24.10	315	12.10	250	150	550	
630	24.10	280	10.70	250	150	525	
630	24.10	250	9.60	250	150	525	
630	24.10	225	8.60	250	100	500	
630	24.10	200	7.70	250	100	475	
630	24.10	180	6.90	250	100	450	
630	24.10	160	6.20	250	100	425	
630	24.10	140	5.40	250	90	400	
630	24.10	125	4.80	250	90	400	
630	24.10	110	4.20	250	90	375	
630	24.10	90	3.50	250	80	375	

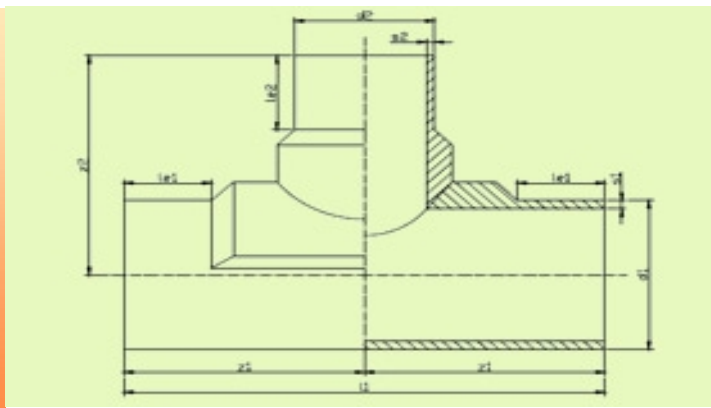

Работно време: Понеделник - Петък
(от 09:00ч. до 18:00ч.)

бул: Цариградско шосе №16, бл. 11, вх. Д, ет. 5, ап. 72 тел/факс: 02/872 76 87,
873 94 37, 870 81 48

E-mail:
office@marivasy.com
marivasy@mail.bg

Управител:

0888/326 906 - Мария Славчева

Отдел оферти и логистика:

0886/709 336 - Димитър Тодоров

0886/715 493 - Нели Борисова

Счетоводство: 02/872 76 87

Работно време: Понеделник - Петък

(от 09:00ч. до 18:00ч.)

Събота

(от 09:00ч. до 14:00ч.)

E-mail:

mariva_sy@mail.bg

Управител склад:

0888/131 498 - Анита Младенова

Търговски мениджър:

0889/257 917 - Полина Филчева

Търговски представител:

0884/183 066 - Светослав Александров

[Кликни тук за да видиш този продукт в интернет страницата на MarivaSy](#)